









Direct Acting Solenoid Valves Model FP01 (Up to 690 bar, 1 litre per minute)



Superior Performance Throughout the Full Operational Range

- Compact Design
- Solenoid Valve
 -  Certified as SIL 3 Capable
- Solenoid Free to Rotate Through 360°
- 316L Stainless Steel Solenoid Enclosure and Valve
- NACE MR-01-75 Internal Wetted and Body Materials (Option)
- Arctic Service Options to -36°C
- Seated Ball Design Offers Extremely Low Leakage (Less Accumulation Required, Smaller Pump Size & Duty)
- Worldwide Solenoid Approvals Ex d, Ex ia, Ex emb and Explosion Proof
 -       
- Low Power
- Up to 690 bar Working Pressure



Features & Benefits

Worldwide Approvals



Solenoid Operator is Free to Rotate 360°



Widest Range of Override Options

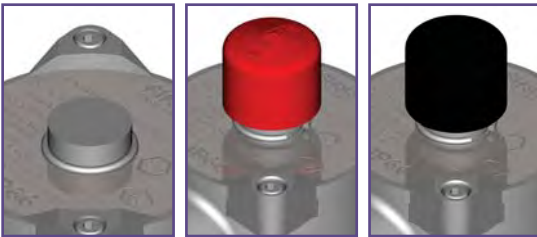

Valve can be Mounted in any Orientation

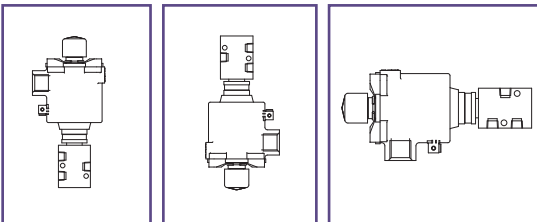

Spacious Enclosure for Ease of Wiring

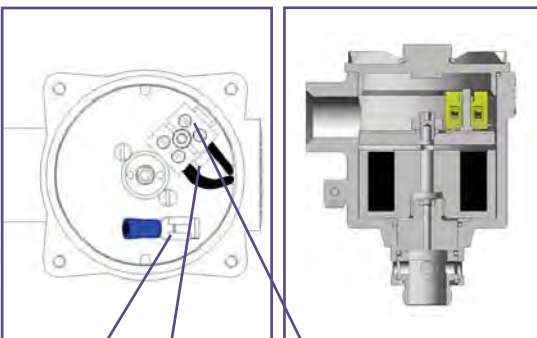

Internal Earth Connection Surge Suppression Diode Ex d (dc) Terminal Block

Standard Solenoid Operator Equipment Design & Build

- Worldwide Approval
- Solenoid operator is free to rotate 360° allowing for an easy cable layout and ease of connection wiring. Solenoid operator internals rotate with the enclosure and prevent cables being pulled out of terminal block.
- Widest range of override options (Auto Reset, Spring Return Manual Override, Stayput Manual Override and Manual Reset).
- Worldwide technical and field support.
- Standard solenoid valve can be mounted in any orientation to simplify installation due to all the components having enhanced rotational capabilities.

Commissioning and Maintenance Benefits for the Standard Solenoid Valve

- Tropicalised solenoid operator design - 316L stainless steel enclosure; stainless steel or Remko B magnetic parts (dependant upon solenoid Ex type) Fully encapsulated coil.
- Spacious solenoid enclosure for ease of wiring.
- No time penalty for heat dissipation before removing solenoid enclosure cover.
- No special high temperature cable requirements.

Accuracy of information
We take care to ensure that product information in this catalogue is reasonably accurate and up-to-date. However, our products are continually developed and updated so to ensure accurate and up-to-date information please refer to the product catalogue issue list on our web-site or contact a member of our sales team.

When selecting a product, the applicable operating system design must be considered to ensure safe use. The products function, material compatibility, adequate ratings, correct installation, operation and maintenance are the responsibilities of the system designer and user.

Quality Assurance
All Bifold products are manufactured to a most stringent QA programme to ensure that every product will give optimum performance and reliability. We are third party certified to BS EN ISO 9001:2008. Functional test certificate, letter of conformity and copies of original mill certificates, providing total traceability are available on request, to BS EN 10204 3.1 where available. We reserve the right to make changes to the specifications and design etc., without prior notice.

Bifold
is a member of the
Bifold Group
of companies

Features & Benefits

SIL 3 Capability, FMEA, Extensive Qualification Testing Coupled with 100% Computerised Diagnostic Test Procedures.

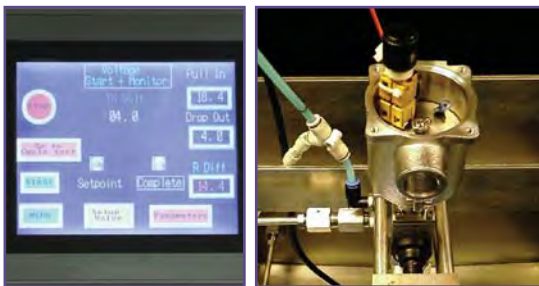

State of the Art Testing



Simple Maintenance



Safety and Environmental Benefits

- **SIL 3 capability:** The product has met manufacturer design process requirements of Safety Integrity Level (SIL) 3.
- Force balanced valve design with high safety factors to de-energise at all pressures in Normally Open and Normally Closed configurations.
- 100% computerised diagnostic testing to ensure each solenoid valve is proven along with confirmed safety factors.
- Bifold has state of the art testing and qualification equipment including endurance, environment, climatic, performance, function and leakage testing.
- The standard solenoid operator is a holding magnet type which ensures the valve will operate in damp conditions. The risk of corrosion to internal components is reduced, unlike other valve types that incorporate a solenoid core tube design with a 'wetted' armature that will only operate in dry air conditions!
- The standard solenoid valve has proven arctic service and low temperature performance.
- Products are manufactured, inspected, assembled and tested in our state of the art production facilities.
- Dry solenoid armature to prevent corrosion and affecting safe shut down.
- Simple maintenance - Removable transient suppression diode on Ex d DC solenoid valve assemblies and removable solenoid coil without removing valve from the tubing.











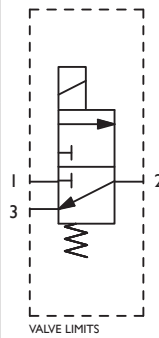







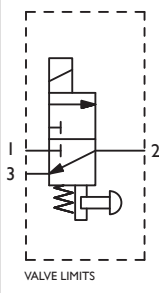







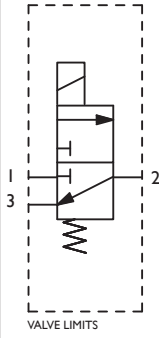



Accuracy of information
We take care to ensure that product information in this catalogue is reasonably accurate and up-to-date. However, our products are continually developed and updated so to ensure accurate and up-to-date information please refer to the product catalogue issue list on our web site or contact a member of our sales team.

When selecting a product, the applicable operating system design must be considered to ensure safe use. The products function, material compatibility, adequate ratings, correct installation, operation and maintenance are the responsibilities of the system designer and user.

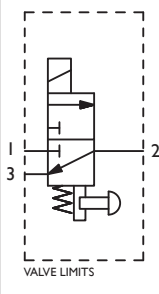
Quality Assurance
All Bifold products are manufactured to a most stringent QA programme to ensure that every product will give optimum performance and reliability. We are third party certified to BS EN ISO 9001:2008. Functional test certificates, letter of conformity and copies of original mill certificates, providing total traceability are available on request, to BS EN 10204 3.1 where available. We reserve the right to make changes to the specifications and design etc., without prior notice.

Preferred Range

DIRECT ACTING SOLENOID VALVES - PREFERRED RANGE

Product	Schematic Representation	Page Number	Product Code	Product Description
 <p>FP01 SI</p>	 <p>VALVE LIMITS</p>	13	FP01/S1/M/32/NC/S/74AT4-24D/36	3 way 2 position, direct acting, Normally Closed, 24Vdc, Auto Reset. ATEX  II 2 GD c, Ex emb IIC T4 Gb IECEx  Ex emb IIC T4 Gb 3.6 Watt, Cv 0.01, 345 bar.
			FP01/S1/M/32/NC/S/77A-24D/30	3 way 2 position, direct acting, Normally Closed, 24Vdc, Auto Reset. ATEX  II 2 GD, Ex d IIC T6 IECEx  Ex d IIC T6 3.0 Watt, Cv 0.01, 345 bar.
			FP01/S1/M/32/NC/S/78A-155	3 way 2 position, direct acting, Normally Closed, Auto Reset. ATEX  II I GD, Ex ia IIC T6 Ga † IECEx  Ex ia IIC T6 Ga 155 Ohms, Cv 0.01, 345 bar.
 <p>FP01 SI Manual Reset</p>	 <p>VALVE LIMITS</p>	13	FP01/S1/M/32/NC/S/74AT4-24D/ML/36	3 way 2 position, direct acting, Normally Closed, 24Vdc, Manual Reset. ATEX  II 2 GD c, Ex emb IIC T4 Gb IECEx  Ex emb IIC T4 Gb 3.6 Watt, Cv 0.01, 345 bar.
			FP01/S1/M/32/NC/S/77A-24D/ML/30	3 way 2 position, direct acting, Normally Closed, 24Vdc, Manual Reset. ATEX  II 2 GD, Ex d IIC T6 IECEx  Ex d IIC T6 3.0 Watt, Cv 0.01, 345 bar.
			FP01/S1/M/32/NC/S/78A-155/ML	3 way 2 position, direct acting, Normally Closed, Manual Reset. ATEX  II I GD, Ex ia IIC T6 Ga † IECEx  Ex ia IIC T6 Ga 155 Ohms, Cv 0.01, 345 bar.
 <p>FP01 S2</p>	 <p>VALVE LIMITS</p>	13	FP01/S2/M/32/NC/S/74AT4-24D/36	3 way 2 position, direct acting, Normally Closed, 24Vdc, Auto Reset. ATEX  II 2 GD c, Ex emb IIC T4 Gb IECEx  Ex emb IIC T4 Gb 3.6 Watt, Cv 0.01, 517 bar.
			FP01/S2/M/32/NC/S/77A-24D/30	3 way 2 position, direct acting, Normally Closed, 24Vdc, Auto Reset. ATEX  II 2 GD, Ex d IIC T6 IECEx  Ex d IIC T6 3.0 Watt, Cv 0.01, 517 bar.
			FP01/S2/M/32/NC/S/78A-155	3 way 2 position, direct acting, Normally Closed, Auto Reset. ATEX  II I GD, Ex ia IIC T6 Ga † IECEx  Ex ia IIC T6 Ga 155 Ohms, Cv 0.01, 517 bar.
 <p>FP01 S2 Manual Reset</p>	 <p>VALVE LIMITS</p>	13	FP01/S2/M/32/NC/S/74AT4-24D/ML/36	3 way 2 position, direct acting, Normally Closed, 24Vdc, Manual Reset. ATEX  II 2 GD c, Ex emb IIC T4 Gb IECEx  Ex emb IIC T4 Gb 3.6 Watt, Cv 0.01, 517 bar.
			FP01/S2/M/32/NC/S/77A-24D/ML/30	3 way 2 position, direct acting, Normally Closed, 24Vdc, Manual Reset. ATEX  II 2 GD, Ex d IIC T6 IECEx  Ex d IIC T6 3.0 Watt, Cv 0.01, 517 bar.
			FP01/S2/M/32/NC/S/78A-155/ML	3 way 2 position, direct acting, Normally Closed, Manual Reset. ATEX  II I GD, Ex ia IIC T6 Ga † IECEx  Ex ia IIC T6 Ga 155 Ohms, Cv 0.01, 517 bar.

† Solenoid must be used in conjunction with a correctly matched Intrinsically Safe (IS) solenoid driver. The valve installer is responsible for a correct and safe IS system.



Accuracy of information
 We take care to ensure that product information in this catalogue is reasonably accurate and up-to-date. However, our products are continually developed and updated so to ensure accurate and up-to-date information please refer to the product catalogue issue list on our web-site or contact a member of our sales team.

When selecting a product, the applicable operating system design must be considered to ensure safe use. The products function, material compatibility, adequate ratings, correct installation, operation and maintenance are the responsibilities of the system designer and user.

Quality Assurance
 All Bifold products are manufactured to a most stringent QA programme to ensure that every product will give optimum performance and reliability. We are third party certified to BS EN ISO 9001:2008. Functional test certificate, letter of conformity and copies of original mill certificates, providing total traceability are available on request, to BS EN 10204 3.1 where available. We reserve the right to make changes to the specifications and design etc., without prior notice.

Preferred Range

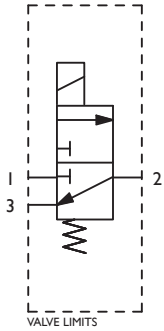

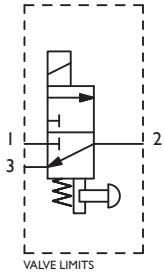







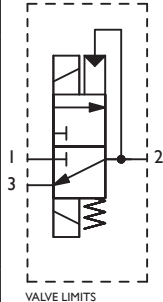



DIRECT ACTING SOLENOID VALVES - PREFERRED RANGE

Product	Schematic Representation	Page Number	Product Code	Product Description
 <p>FP01 S3</p>		13	FP01/S3/M/32/NC/S/74AT4-24D/36	3 way 2 position, direct acting, Normally Closed, 24Vdc, Auto Reset. ATEX II 2 GD c, Ex emb IIC T4 Gb IECEx Ex emb IIC T4 Gb 3.6 Watt, Cv 0.01, 690 bar.
			FP01/S3/M/32/NC/S/77A-24D/30	3 way 2 position, direct acting, Normally Closed, 24Vdc, Auto Reset. ATEX II 2 GD, Ex d IIC T6 IECEx Ex d IIC T6 3.0 Watt, Cv 0.01, 690 bar.
			FP01/S3/M/32/NC/S/78A-155	3 way 2 position, direct acting, Normally Closed, Auto Reset. ATEX II I GD, Ex ia IIC T6 Ga † IECEx Ex ia IIC T6 Ga 155 Ohms, Cv 0.01, 690 bar.
 <p>FP01 S3 Manual Reset</p>		13	FP01/S3/M/32/NC/S/74AT4-24D/ML/36	3 way 2 position, direct acting, Normally Closed, 24Vdc, Manual Reset. ATEX II 2 GD c, Ex emb IIC T4 Gb IECEx Ex emb IIC T4 Gb 3.6 Watt, Cv 0.01, 690 bar.
			FP01/S3/M/32/NC/S/77A-24D/ML/30	3 way 2 position, direct acting, Normally Closed, 24Vdc, Manual Reset. ATEX II 2 GD, Ex d IIC T6 IECEx Ex d IIC T6 3.0 Watt, Cv 0.01, 690 bar.
			FP01/S3/M/32/NC/S/78A-155/ML	3 way 2 position, direct acting, Normally Closed, Manual Reset. ATEX II I GD, Ex ia IIC T6 Ga † IECEx Ex ia IIC T6 Ga 155 Ohms, Cv 0.01, 690 bar.

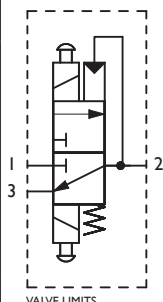
† Solenoid must be used in conjunction with a correctly matched Intrinsically Safe (IS) solenoid driver. The valve installer is responsible for a correct and safe IS system.

Solenoid Valves



DIRECT ACTING SOLENOID VALVES				
Product	Schematic Representation	Page Number	Product Code	Product Description
 <p>FP01 S1 / S1, S2 / S2 & S3 / S3</p>		14	FP01/S1/S1/M/32/NC/S/74AT4-24D/SB/36	3 way 2 position, direct acting, Normally Closed, 24Vdc, pulse operated, bi-stable, hydraulically latched, fail to close on loss of pressure, Auto Reset. ATEX  II 2 GD c, Ex emb IIC T4 Gb IECEx  Ex emb IIC T4 Gb 3.6 Watt, Cv 0.01, 345 bar.
			FP01/S2/S2/M/32/NC/S/77A-24D/SB/30	3 way 2 position, direct acting, Normally Closed, 24Vdc, pulse operated, bi-stable, hydraulically latched, fail to close on loss of pressure, Auto Reset. ATEX  II 2 GD, Ex d IIC T6 IECEx  Ex d IIC T6 3.0 Watt, Cv 0.01, 517 bar.
			FP01/S3/S3/M/32/NC/S/78A-155/SB	3 way 2 position, direct acting, Normally Closed, pulse operated, bi-stable, hydraulically latched, fail to close on loss of pressure, Auto Reset. ATEX  II 1 GD, Ex ia IIC T6 Ga † IECEx  Ex ia IIC T6 Ga † 155 Ohms, Cv 0.01, 690 bar.
 <p>FP01 S1 / S1, S2 / S2 & S3 / S3 Manual Override Spring Return</p>		14	FP01/S1/S1/M/32/NC/S/74AT4-24D/SB/M/36	3 way 2 position, direct acting, Normally Closed, 24Vdc, pulse operated, bi-stable, hydraulically latched, fail to close on loss of pressure. *Manual Override. ATEX  II 2 GD c, Ex emb IIC T4 Gb IECEx  Ex emb IIC T4 Gb 3.6 Watt, Cv 0.01, 345 bar.
			FP01/S2/S2/M/32/NC/S/77A-24D/SB/M/30	3 way 2 position, direct acting, Normally Closed, 24Vdc, pulse operated, bi-stable, hydraulically latched, fail to close on loss of pressure. *Manual Override. ATEX  II 2 GD, Ex d IIC T6 IECEx  Ex d IIC T6 3.0 Watt, Cv 0.01, 517 bar.
			FP01/S3/S3/M/32/NC/S/78A-155/SB/M	3 way 2 position, direct acting, Normally Closed, pulse operated, bi-stable, hydraulically latched, fail to close on loss of pressure. *Manual Override. ATEX  II 1 GD, Ex ia IIC T6 Ga † IECEx  Ex ia IIC T6 Ga † 155 Ohms, Cv 0.01, 690 bar.

† Solenoid must be used in conjunction with a correctly matched Intrinsically Safe (IS) solenoid driver. The valve installer is responsible for a correct and safe IS system.
 * Manual Override Spring Return.

FP01 - S1 / S1, S2 / S2 & S3 / S3

For the complete S1 / S1, S2 / S2 & S3 / S3 range, please see the selection chart on Page 14.

Accuracy of information
 We take care to ensure that product information in this catalogue is reasonably accurate and up-to-date. However, our products are continually developed and updated so to ensure accurate and up-to-date information please refer to the product catalogue issue list on our web site or contact a member of our sales team.

When selecting a product, the applicable operating system design must be considered to ensure safe use. The products function, material compatibility, adequate ratings, correct installation, operation and maintenance are the responsibilities of the system designer and user.

Quality Assurance
 All Bifold products are manufactured to a most stringent QA programme to ensure that every product will give optimum performance and reliability. We are third party certified to BS EN ISO 9001:2008. Functional test certificate, letter of conformity and copies of original mill certificates, providing total traceability are available on request, to BS EN 10204 3.1 where available. We reserve the right to make changes to the specifications and design etc., without prior notice.



Overview

Materials of Construction

Solenoid enclosure and valve manufactured from 316L stainless steel as standard.
 Internal components are constructed from 316L stainless steel, AISI 440C, CA104 aluminium bronze and ceramic as standard.
 Alternative materials are available for NACE MR-01-75 compliance.
 Valve seals are supplied in Nitrile as standard. Alternative elastomers available for extreme conditions and to suite media.
 Springs are manufactured from 316S42 stainless steel as standard.
 Fasteners are metric A4 18 / 10 grade stainless steel; equivalent to 316L grade stainless steel.

Technical Data

Operating Performance for FP01

Duty cycle 100% continuously rated / energised.
 Surge suppression diode is fitted on all Ex d dc solenoid coils as standard.
 Response times - pull in < 100ms, drop out < 70ms.
 Solenoid Insulation - Class H.
 Pull in volts to 90% of nominal. (checked at FAT to be within specified limits to guarantee safety factors).
 Maximum volts at 110% of nominal.
 IP66 & IP67 Ingress Protection to IEC 60529 and NEMA 4X for standard 7 series solenoid enclosures.
 Bifold solenoid valves must be installed, operated and maintained in accordance with the relevant Bifold installation, operating and maintenance instructions, relevant installation rules and codes of practice.

Product Options

Certification & Approval available



SIL 3 capability: The product has met manufacturer design process requirements of Safety Integrity Level (SIL) 3 in accordance with IEC 61508.

Solenoid valve assemblies can be mounted in any orientation. Solenoid enclosure can be rotated relative to the pilot stage valve body to suit cable entry.

Working pressure up to 690 bar. Maximum working pressure according to valve model.

Operating media - Mineral oils, water glycol mixtures, sea water (filtered) and some chemicals.

For operating temperature range, please see solenoid valve type and seal options.

Manual Reset & Manual Override operator options.

Arctic Service options to -36°C.

Flow Performance

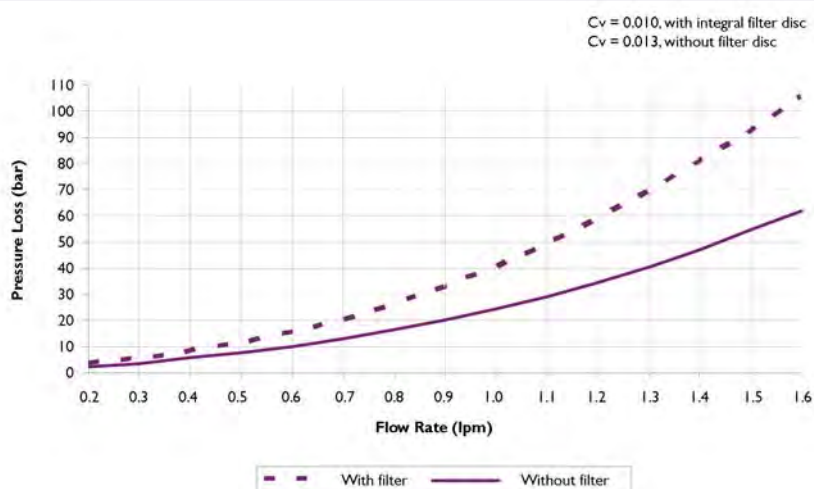

Certification Details

Certification & Approval Details

Type 74 Solenoid

ATEX, Certificate Number Baseefa 09ATEX0040X.
 II 2GD c Ex emb IIC T4 Gb Tamb -25°C to +50°C.
 II 2GD c Ex emb IIC T3 Gb Tamb -25°C to +55°C.

IECEx, Certificate Number IECEx Bas 09.0012X.
 Ex emb IIC T4 Gb Tamb -25°C to +50°C.
 Ex emb IIC T3 Gb Tamb -25°C to +55°C.

Dual Labelled/Marked

Type 77 Solenoid

ATEX, Certificate Number Baseefa 10ATEX0026.
 II 2 GD Ex d IIC T6 (Tamb -60°C to +40°C).
 II 2 GD Ex d IIC T5 (Tamb -60°C to +55°C).
 II 2 GD Ex d IIC T4 (Tamb -60°C to +90°C).

IECEx, Certificate Number IECEx Bas 10.0008.
 Ex d IIC T6 (Tamb -60°C to +40°C).
 Ex d IIC T5 (Tamb -60°C to +55°C).
 Ex d IIC T4 (Tamb -60°C to +90°C).

Dual Labelled/Marked

Type 78 Solenoid

ATEX, Certificate Number Baseefa 02ATEX0124X.
 II I GD Ex ia IIC T6 Ga (Tamb = -60°C to +60°C).
 II I GD Ex ia IIC T4 Ga (Tamb = -60°C to +95°C).

IECEx, Certificate Number IECEx Bas 09.0092X.
 Ex ia IIC T6 Ga (Tamb = -60°C to +60°C).
 Ex ia IIC T4 Ga (Tamb = -60°C to +95°C).

Dual Labelled/Marked

Type 77 Solenoid

CSA (US), Certificate Number I398692.
 Class I, Division I, Groups B, C & D for both Canada & USA.
 Ex d IIC for Canada, AEx d IIC for USA.
 T85°C -60°C to +40°C ambient.
 T100°C -60°C to +55°C ambient.
 T135°C -60°C to +90°C ambient.

Type 77 Solenoid

ATEX, Certificate Number Baseefa 10ATEX0026.
 II 2GD Ex d IIC T6 (Tamb -60°C to +40°C).
 II 2GD Ex d IIC T5 (Tamb -60°C to +55°C).
 II 2GD Ex d IIC T4 (Tamb -60°C to +90°C).

Dual Labelled/Marked

Type 77 Solenoid

INMETRO, Certificate Number CEPEL-EX-097/2003X.
 BR-Ex d IIC T6 -60°C to +40°C ambient.
 BR-Ex d IIC T5 -60°C to +55°C ambient.
 BR-Ex d IIC T4 -60°C to +90°C ambient.

Type 78 Solenoid

INMETRO, Certificate Number CEPEL-EX-532/05.
 BR-Ex ia IIC T6 -60°C to +40°C ambient.
 BR-Ex ia IIC T4 -60°C to +95°C ambient.

Type 77 Solenoid

GOST, Certificate Number B00763, RTN.
 Ex d IIC T6 -60°C to +40°C ambient.
 Ex d IIC T5 -60°C to +55°C ambient.
 Ex d IIC T4 -60°C to +90°C ambient.

Type 78 Solenoid

GOST, Certificate Number B00015, RTN.
 Permit Number PPC 00-28504.
 Ex ia IIC T6 -60°C to +40°C ambient.
 Ex ia IIC T5 -60°C to +55°C ambient.
 Ex ia IIC T4 -60°C to +90°C ambient.

Type 77 & 78 Solenoid

GOST K, GGTN K Permit, Kazakhstan, BIF 7727 2.

Label Rationalisation

The temperature details on our solenoid valve labels have, to date, been laid out with a single ambient range and 'T' rating, as follows :-

- 77A3 - T4 (-60°C ≤ Tamb ≤ +90°C)
- or 77A6 - T5 (-60°C ≤ Tamb ≤ +55°C)
- or 77A9 - T6 (-60°C ≤ Tamb ≤ +40°C)

These are in the process of being replaced with a single label which covers all potential temperature parameters. Therefore the label will for example, read as follows :-

$$77A \left\{ \begin{array}{l} T4 (-60^\circ\text{C} \leq T_{amb} \leq +90^\circ\text{C}) \\ T5 (-60^\circ\text{C} \leq T_{amb} \leq +55^\circ\text{C}) \\ T6 (-60^\circ\text{C} \leq T_{amb} \leq +40^\circ\text{C}) \end{array} \right\}$$

For solenoid type 74, the maximum permissible ambient temperature is subject to the coil Wattage. Please see page 9. Please note that operation ambients are dependent upon seal types.

Accuracy of information
 We take care to ensure that product information in this catalogue is reasonably accurate and up-to-date. However, our products are continually developed and updated so to ensure accurate and up-to-date information please refer to the product catalogue issue list on our web-site or contact a member of our sales team.

When selecting a product, the applicable operating system design must be considered to ensure safe use. The products function, material compatibility, adequate ratings, correct installation, operation and maintenance are the responsibilities of the system designer and user.

Quality Assurance
 All Bifold products are manufactured to a most stringent QA programme to ensure that every product will give optimum performance and reliability. We are third party certified to BS EN ISO 9001:2008. Functional test certificates, letter of conformity and copies of original mill certificates, providing total traceability are available on request, to BS EN 10204 3.1 where available. We reserve the right to make changes to the specifications and design etc., without prior notice.



Port Connections

Port Connections (FP01)

PORT CONNECTIONS TABLE			
Configuration	Pressure	Service	Vent
Normally Closed	1	2	3
Normally Open	3	2	1
Selector	1 & 3	2	N/A
Diverter	2	1 & 3	N/A

For port connections, please refer to selection chart ordering example on pages 13 & 14.

Product Weights

Approximate Standard Product Weights

PRODUCT WEIGHTS	
Product	Approximate Weight (Excluding Sub-base) (Kg)
S1, S2 & S3	2.5
S1 / S1, S2 / S2 & S3 / S3	5

Solenoid Coil Spare

Solenoid Coil Spare Selection Chart - Ordering Example Type 74 & 77

109		Coil Type
XXX Voltage (V)	74 (Ex emb) 24 & 48 Vdc 77 (Ex d) 12, 24, 48 & 110 Vdc 77 (Ex d) 110 & 240 Vac	Voltage
XX Power (W)	74 (Ex emb) 1.8 & 3.6 Watts 77 (Ex d) 1.5 & 3.0 Watts	Power
EXM		74 Only
109-24DC-30 - EXM		Ordering Example

For detailed information, please contact Bifold sales department.

Solenoid Coil Spare

Solenoid Coil Spare Selection Chart Ordering Example Type 78

109		Coil Type
XXX Nominal Voltage	78 (Ex ia) 12V	Nominal Voltage
XX Resistance (Ω)	78 (Ex ia) 155 Ohms	Resistance †
109-12 - 155		Ordering Example

† Solenoid must be used in conjunction with a correctly matched Intrinsically Safe (IS) solenoid driver. The valve installer is responsible for a correct and safe IS system.

Seal Repair Kit

Seal Repair Kit Selection Chart - Ordering Example (FP01)









FP01		Model Code
S1 345 bar S2 517 bar S3 690 bar	S1 / S1 345 bar S2 / S2 517 bar S3 / S3 690 bar	Maximum Valve Pressure
M	Sub-base Mounting	Connections
22 32	2-way, 2-position 3-way, 2-position	Valve Configuration
NC NO SV DV	Normally Closed Normally Open Selector Valve Diverter Valve	
	3 / 2 Only	
S V SA	Nitrile (standard) Viton Nitrile (Low Temperature)	
	RK Repair Kit	Repair Kit
FP01-SX-M32-NC-S-RK		Ordering Example

When ordering the seal repair kits, please ensure that the serial number of the valve to be overhauled is submitted with the enquiry / order.

Ex emb Options

Options Table I 74 (Ex emb)

SOLENOID OPTIONS TABLE I 74 (Ex emb)

Product Type	Solenoid Order Code	Typical Apparatus Code	Standard Voltage	Power Consumption (W)	CV Rate	Temperature Range (°C)	Ingress Protection	Cable Entry Connection	Certification Options
 FP01 (S1)	74	Ex emb IIC T3 / T4	24Vdc 48Vdc	1.8 3.6	0.01	Media # -20°C to +40°C -25°C to +40°C -20°C to +55°C -25°C to +55°C Ambient -25°C to +55°C (T3) (Up to 3.0W) -25°C to +50°C (T4) (Up to 4.0W) -25°C to +40°C (T3) (3.0W - 6.8W)	IP66 IP67 NEMA 4X	M20 x 1.5 (1/2" NPT Option)	
 FP01 (S2)									
 FP01 (S3)									
 FP01 (S1 / S1)	74	Ex emb IIC T3 / T4	24Vdc 48Vdc	1.8 3.6	0.01	Media # -20°C to +40°C -25°C to +40°C -20°C to +55°C -25°C to +55°C Ambient -25°C to +55°C (T3) (Up to 3.0W) -25°C to +50°C (T4) (Up to 4.0W) -25°C to +40°C (T3) (3.0W - 6.8W)	IP66 IP67 NEMA 4X	M20 x 1.5 (1/2" NPT Option)	
 FP01 (S2 / S2)									
 FP01 (S3 / S3)									

For detailed information on certification, please see page 8.

Other Wattages available upon request.

Permissible media operating temperatures are dependent upon the selected O-Ring material. Please refer to the product selection charts on pages 13 to 14.

Accuracy of information
We take care to ensure that product information in this catalogue is reasonably accurate and up-to-date. However, our products are continually developed and updated so to ensure accurate and up-to-date information please refer to the product catalogue issue list on our web-site or contact a member of our sales team.









When selecting a product, the applicable operating system design must be considered to ensure safe use. The products function, material compatibility, adequate ratings, correct installation, operation and maintenance are the responsibilities of the system designer and user.

Quality Assurance
All Bifold products are manufactured to a most stringent QA programme to ensure that every product will give optimum performance and reliability. We are third party certified to BS EN ISO 9001:2008. Functional test certificate, letter of conformity and copies of original mill certificates, providing total traceability are available on request, to BS EN 10204 3.1 where available. We reserve the right to make changes to the specifications and design etc., without prior notice.



Ex d Options

Options Table 2 77 (Ex d)

SOLENOID OPTIONS TABLE 2 77 (Ex d)									
Product Type	Solenoid Order Code	Typical Apparatus Code	Standard Voltage	Power Consumption (W)	CV Rate	Temperature Range (°C)	Ingress Protection	Cable Entry Connection	Certification Options
 FP01 (S1)	77	Ex d IIC T6, T5 or T4	12 Vdc 24 Vdc 48 Vdc 110 Vdc 110 Vac 240 Vac 50 or 60 Hz	1.5 3.0	0.01	Media # -20°C to +90°C (T4) -60°C to +90°C (T4) Ambient -60°C to +40°C (T6) -60°C to +55°C (T5) -60°C to +90°C (T4)	IP66 IP67 NEMA 4X	M20 x 1.5 (½" NPT Option)	
 FP01 (S2)									
 FP01 (S3)									
 FP01 (S1 / S1)	77	Ex d IIC T6, T5 or T4	12 Vdc 24 Vdc 48 Vdc 110 Vdc 110 Vac 240 Vac 50 or 60 Hz	1.5 3.0	0.01	Media # -20°C to +90°C (T4) -60°C to +90°C (T4) Ambient -60°C to +40°C (T6) -60°C to +55°C (T5) -60°C to +90°C (T4)	IP66 IP67 NEMA 4X	M20 x 1.5 (½" NPT Option)	
 FP01 (S2 / S2)									
 FP01 (S3 / S3)									









For detailed information on certification, please see page 8.

Other Wattages available upon request.

Permissible media operating temperatures are dependent upon the selected O-Ring material. Please refer to the product selection charts on pages 13 to 14.

Ex ia Options

Options Table 3 78 (Ex ia)

SOLENOID OPTIONS TABLE 3 78 (Ex ia)							
Product Type	Solenoid Order Code	Typical Apparatus Code	CV Rate	Temperature Range	Ingress Protection	Cable Entry Connection	Certification Options
 FP01 (S1)	78 †	Ex ia IIC T6 or T4	0.01	Media # -20°C to +95°C -60°C to +95°C Ambient -60°C to +60°C (T6) -60°C to +95°C (T4)	IP66 IP67 NEMA 4X	M20 x 1.5 (1/2" NPT Option)	
 FP01 (S2)							
 FP01 (S3)							
 FP01 (S1 / S1)	78 †	Ex ia IIC T6 or T4	0.01	Media # -20°C to +95°C -60°C to +95°C Ambient -60°C to +60°C (T6) -60°C to +95°C (T4)	IP66 IP67 NEMA 4X	M20 x 1.5 (1/2" NPT Option)	
 FP01 (S2 / S2)							
 FP01 (S3 / S3)							

For detailed information on certification, please see page 8.

† Solenoid must be used in conjunction with a correctly matched Intrinsically Safe (IS) solenoid driver. The valve installer is responsible for a correct and safe IS system.

Permissible media operating temperatures are dependent upon the selected O-Ring material. Please refer to the product selection charts on pages 13 to 14.

Safety Parameters: Type 78

U_i = 31 V, I_i = 210 mA, P_i = 1.5 W, C_i = 0 µF, L_i = 0 mH

Coil Resistance : 155 Ohm ± 5%

Minimum Current @ solenoid coil = 80 mA

Accuracy of information
We take care to ensure that product information in this catalogue is reasonably accurate and up-to-date. However, our products are continually developed and updated so to ensure accurate and up-to-date information please refer to the product catalogue issue list on our web-site or contact a member of our sales team.

When selecting a product, the applicable operating system design must be considered to ensure safe use. The products function, material compatibility, adequate ratings, correct installation, operation and maintenance are the responsibilities of the system designer and user.

Quality Assurance
All Bifold products are manufactured to a most stringent QA programme to ensure that every product will give optimum performance and reliability. We are third party certified to BS EN ISO 9001:2008. Functional test certificates, letter of conformity and copies of original mill certificates, providing total traceability are available on request, to BS EN 10204 3.1 where available. We reserve the right to make changes to the specifications and design etc., without prior notice.



FP01 (S1, S2 & S3)

Dimensional Drawing

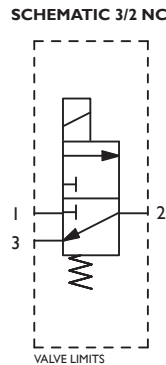
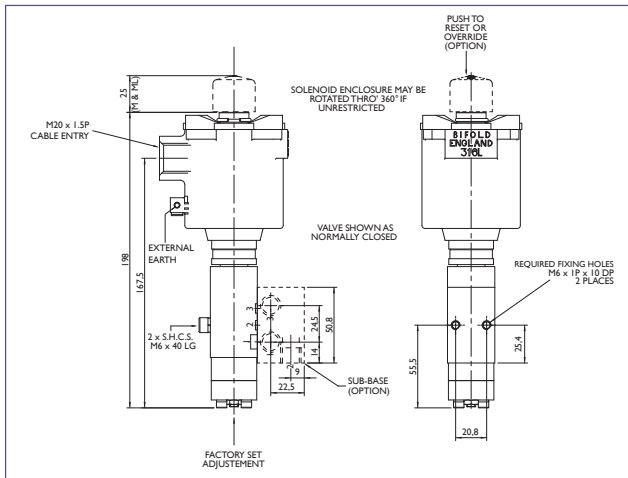

Wiring Diagrams

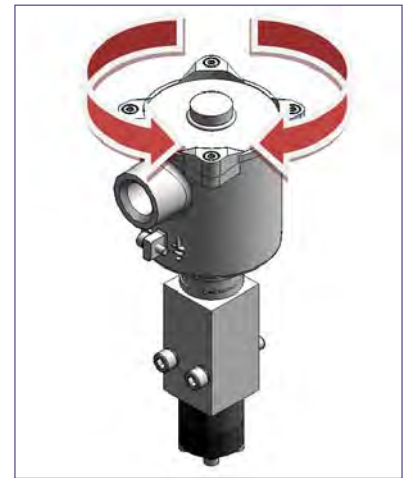
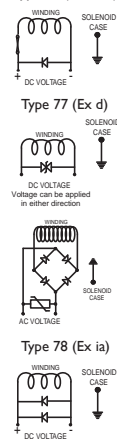

FP01 Selection Chart - Ordering Example

FP01		Model Code	
S1 345 bar S2 517 bar S3 690 bar	Direct acting, spring return		Maximum Valve Pressure
M	Sub-base Mounting		Connections
22 32	2-way, 2-position (effected by omitting / plugging one port in the sub-base) 3-way, 2-position		Valve Configuration
NC NO SV DV	Normally Closed Normally Open Selector Valve } 3 / 2 Only Diverter Valve }		
S V SA	Nitrile (standard) (-30°C to +130°C) Viton (-20°C to +180°C) Nitrile (Low Temperature) (-36°C to +180°C)		
XX	Refer to solenoid options tables.	74 (Ex emb) Page 10 - Table 1 77 (Ex d) Page 11 - Table 2 78 (Ex ia) Page 12 - Table 3	Solenoid
A G I U	ATEX/IECEX Dual Certified/Labelled GOST INMETRO CSA (US) ATEX Dual Certified/Labelled	74(Ex emb)	Solenoid Approval
		77(Ex d)	
		78(Ex ia)	
T4	Class ≤ 4.0 W (50°C maximum ambient temperature)		Ex emb 'T' Option
XXX	Voltage, refer to Solenoid option tables.	74 (Ex emb) Page 10 - Table 1 77 (Ex d) Page 11 - Table 2	Voltage
XX	Resistance (Ω)	78 (Ex ia) - 155 Ohms Page 12 - Table 3	Resistance †
M ML MOR	Electrical to switch or temporary manual override Electrical and manual required Electrical to switch or stayput manual override		Options
XX	Power (W)	74 (Ex emb) - 1.8 & 3.6 Watts Page 10 - Table 1 77 (Ex d) - 1.5 & 3.0 Watts Page 11 - Table 2	Power
K85	1/2" NPT cable entry		Option
H2S	NACE MR-01-75 compliant internal wetted and body materials		Option
M221 M437	1/4" NPT 1/4" BSPP		Sub-Base Options

FP01 / S1 / M/32 / NC / S / 74 A T4-24D / ML/36 / K85 / H2S / [M221]

Ordering Example

For the shaded block sections, please refer to the same shaded sections on pages 10, 11 & 12.

† Solenoid must be used in conjunction with a correctly matched Intrinsically Safe (IS) solenoid driver. The valve installer is responsible for a correct and safe IS system. The solenoid valve installation operating and maintenance instruction reference is OP0165.

FP01 (S1/S1,S2/S2&S3/S3)

Dimensional Drawing

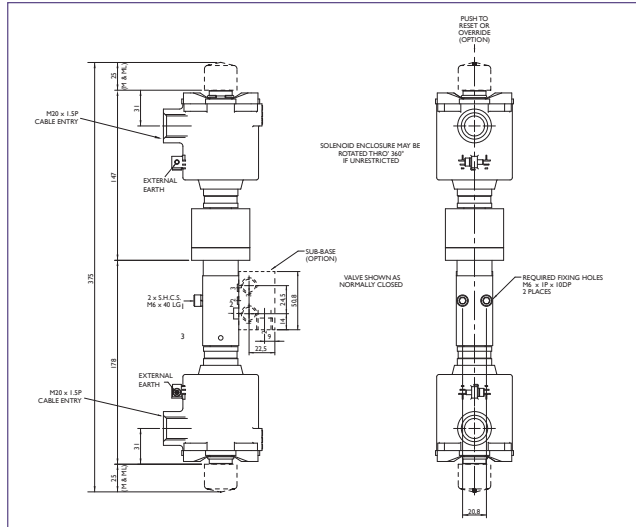

SCHEMATIC 3/2 NC

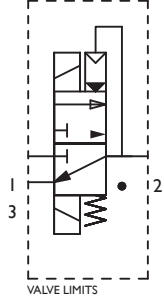

Wiring Diagrams

Type 74 (Ex emb)

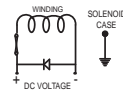

Type 77 (Ex d)

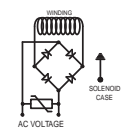
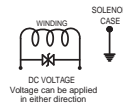

Type 78 (Ex ia)

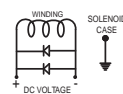

FP01 Selection Chart - Ordering Example

FP01				Model Code
S1 / S1 S2 / S2 S3 / S3	345 bar 517 bar 690 bar	Pulse operated, hydraulically latched, spring bias to close on loss of pressure		Maximum Valve Pressure
M	Sub-base Mounting			Connections
32	3-way, 2-position			Valve Configuration
NC	Normally Closed			Valve Configuration
S V SA	Nitrile (standard) Viton Nitrile (Low Temperature)	(-30°C to +130°C) (-20°C to +180°C) (-36°C to +180°C)	For maximum operating temperatures see 'T' Rating Limitations for Ex emb, Ex d & Ex ia on pages 10, 11 & 12.	O-ring Material
XX	Refer to solenoid options tables.	74 (Ex emb) 77 (Ex d) 78 (Ex ia)	Page 10 - Table 1 Page 11 - Table 2 Page 12 - Table 3	Solenoid
A G I U	ATEX/IECEX Dual Certified/Labelled GOST INMETRO CSA (US) ATEX Dual Certified/Labelled		74(Ex emb) 77(Ex d) 78(Ex ia)	Solenoid Approval
T4	Class ≤ 4.0 W	(50°C maximum ambient temperature)		Ex emb 'T' Option
XXX	Voltage, refer to Solenoid option tables.	74 (Ex emb) 77 (Ex d)	Page 10 - Table 1 Page 11 - Table 2	Voltage
XX	Resistance (Ω)	78 (Ex ia) - 155 Ohms	Page 12 - Table 3	Resistance †
SB	Spring bias to close on loss of hydraulic supply pressure			Default Position
M ML MOR	Electrical to switch or temporary manual override Electrical and manual required Electrical to switch or stayput manual override			Options
XX	Power (W)	74 (Ex emb) - 1.8 & 3.6 Watts 77 (Ex d) - 1.5 & 3.0 Watts	Page 10 - Table 1 Page 11 - Table 2	Power
K85	1/2" NPT cable entry			Option
H2S	NACE MR-01-75 compliant internal wetted and body materials			Option
M221 M437	1/4" NPT 1/4" BSPP			Sub-Base Options
FP01/S1/S1/M/32/NC/S / 74 A T4-24D/SB / M / 36 / K85 / HS2 / [M221]				Ordering Example

For the shaded block sections, please refer to the same shaded sections on pages 10, 11 & 12.
 † Solenoid must be used in conjunction with a correctly matched Intrinsically Safe (IS) solenoid driver. The valve installer is responsible for a correct and safe IS system. The solenoid valve installation operating and maintenance instruction reference is OP0165.

Accuracy of information
 We take care to ensure that product information in this catalogue is reasonably accurate and up-to-date. However, our products are continually developed and updated so to ensure accurate and up-to-date information please refer to the product catalogue issue list on our web-site or contact a member of our sales team.

When selecting a product, the applicable operating system design must be considered to ensure safe use. The products function, material compatibility, adequate ratings, correct installation, operation and maintenance are the responsibilities of the system designer and user.

Quality Assurance
 All Bifold products are manufactured to a most stringent QA programme to ensure that every product will give optimum performance and reliability. We are third party certified to BS EN ISO 9001:2008. Functional test certificates, letter of conformity and copies of original mill certificates, providing total traceability are available on request, to BS EN 10204 3.1 where available. We reserve the right to make changes to the specifications and design etc., without prior notice.



Interface Details

Bifold Supplied Sub-Base Detail

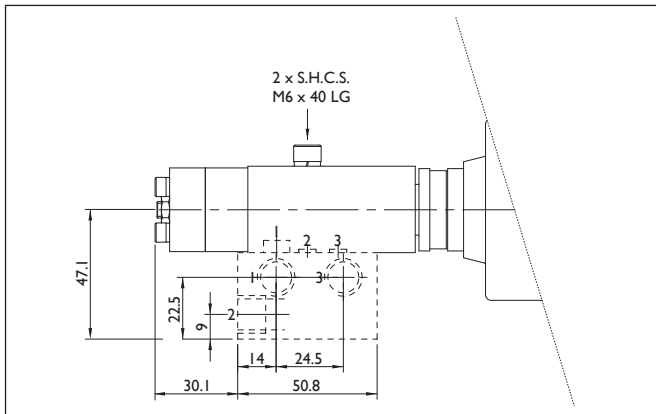

Interface Detail (For Customer Designed Sub-Base)

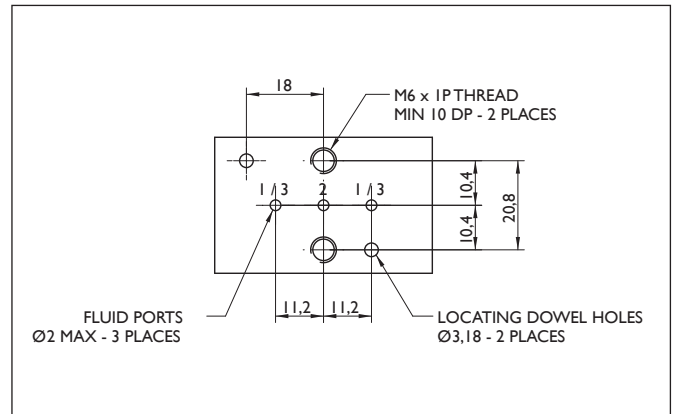

Surface Finish Requirements

Valve Manifold Mounting - Surface Finish Requirements:-
(applicable to full extent of valve/manifold interface)

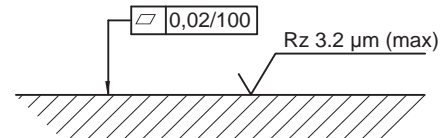

Configurations

3-Way, 2-Position Normally Closed (For 2-Way Valve Port 3 Must Be Plugged)

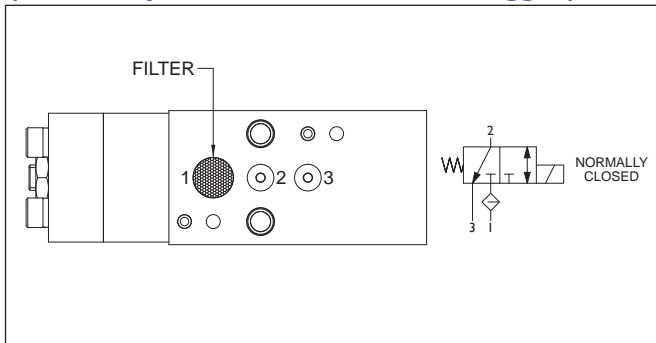

3-Way, 2-Position Normally Open (For 2-Way Valve Port 1 Must Be Plugged)

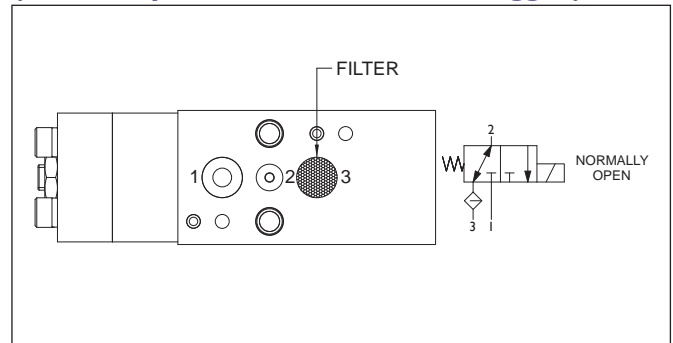

3-Way Diverter (For S1,S2 & S3 only)

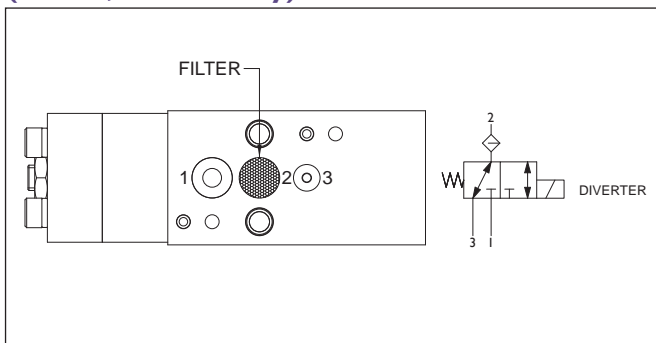

3-Way Selector (For S1,S2 & S3 only)

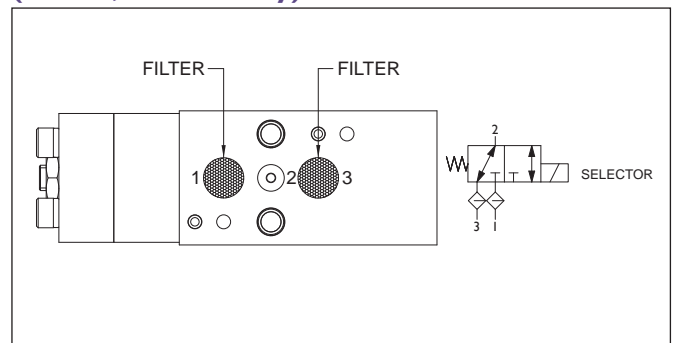

Options

Product Options

The range of products displayed in this brochure, are designed to accommodate all the options shown below. If the style or arrangement required for your application is not shown, please contact our office with full description and specification details.



Type M - Electrical to Switch or Temporary Manual Override (Spring Return)

Manual Override Type M

The solenoid valve switches on and off with the electrical supply. The manual override button can be pressed to operate the valve when the solenoid is in the electrically de-energised position. The manual override is non-detented, i.e. does not latch in position. When the button is released, the valve spring returns.

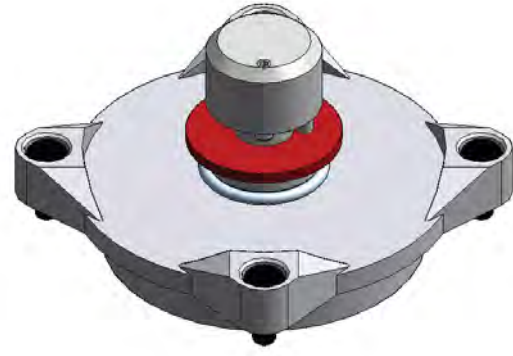

Type MOR - Electrical to Switch or Temporary Manual Rotary Override (Stayput)

Manual Rotary Override Type MOR

The solenoid valve switches on and off with the electrical supply. The manual override button is rotated through $\frac{3}{4}$ turn to operate the valve when the solenoid is in the electrically de-energised position. The manual override is detented, i.e. remains in position until rotated back to its original position when the valve spring returns.

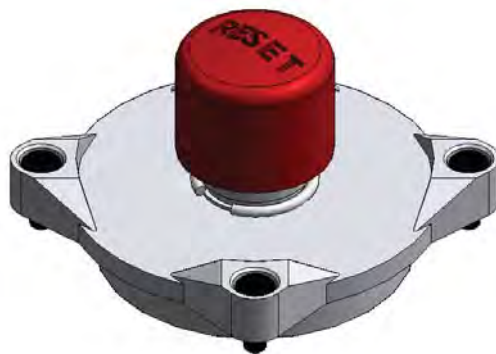

Type ML - Electrical and Manual Required to Latch

Manual Reset Type ML

Apply the electrical signal and press the reset button. The valve moves to the energised position and will not de-energise until the electrical supply is removed. The manual reset is non-detented, spring return, i.e. does not latch in position. The valve cannot be moved to the energised position by pressing the button if there is no electrical supply to the solenoid.

Accuracy of information
We take care to ensure that product information in this catalogue is reasonably accurate and up-to-date. However, our products are continually developed and updated so to ensure accurate and up-to-date information please refer to the product catalogue issue list on our web site or contact a member of our sales team.

When selecting a product, the applicable operating system design must be considered to ensure safe use. The products function, material compatibility, adequate ratings, correct installation, operation and maintenance are the responsibilities of the system designer and user.

Quality Assurance
All Bifold products are manufactured to a most stringent QA programme to ensure that every product will give optimum performance and reliability. We are third party certified to BS EN ISO 9001:2008. Functional test certificates, letter of conformity and copies of original mill certificates, providing total traceability are available on request, to BS EN 10204 3.1 where available. We reserve the right to make changes to the specifications and design etc., without prior notice.

Typical Assemblies



Typical Valve Assembly Showing FP01 Solenoid Valves - Manual Reset

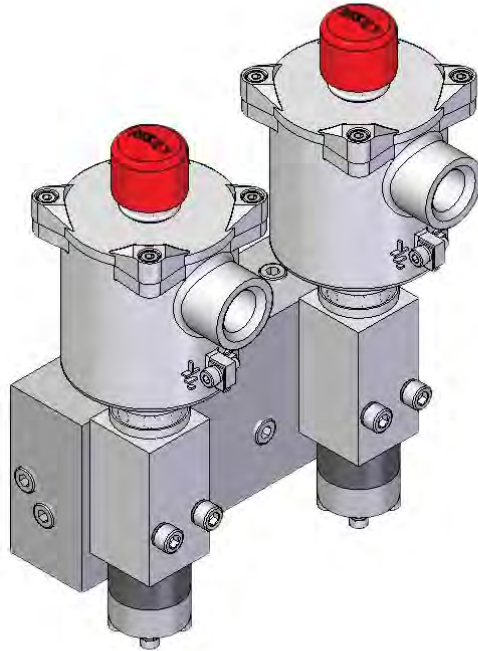

Schematic

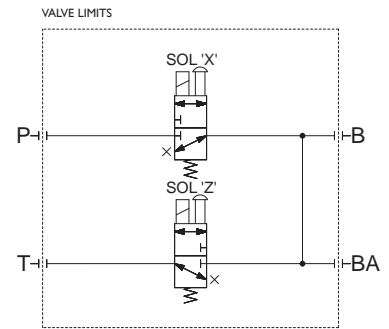

Typical Valve Assembly Showing FP01 Solenoid Valves

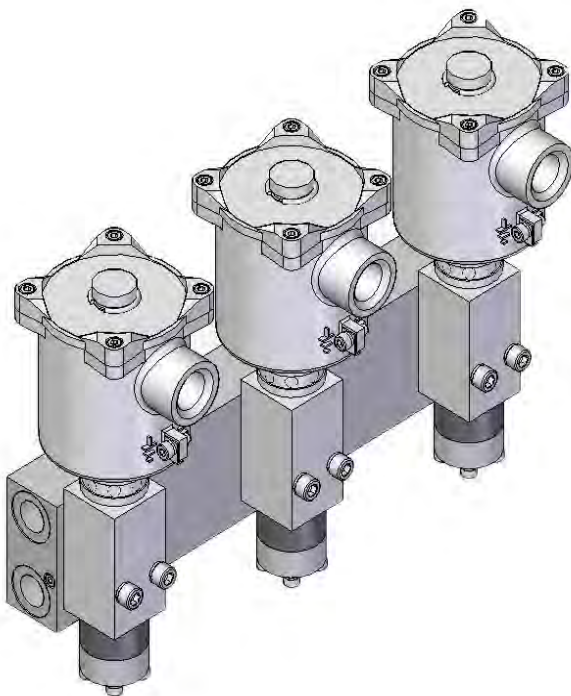

Schematic

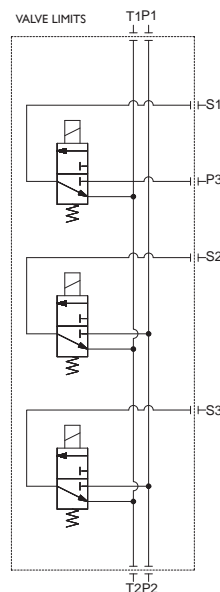

Accuracy of information
We take care to ensure that product information in this catalogue is reasonably accurate and up-to-date. However, our products are continually developed and updated so to ensure accurate and up-to-date information please refer to the product catalogue issue list on our web site or contact a member of our sales team.

When selecting a product, the applicable operating system design must be considered to ensure safe use. The products function, material compatibility, adequate ratings, correct installation, operation and maintenance are the responsibilities of the system designer and user.

Quality Assurance
All Bifold products are manufactured to a most stringent QA programme to ensure that every product will give optimum performance and reliability. We are third party certified to BS EN ISO 9001:2008. Functional test certificates, letter of conformity and copies of original mill certificates, providing total traceability are available on request, to BS EN 10204 3.1 where available. We reserve the right to make changes to the specifications and design etc., without prior notice.

**Instrument, Process,
Directional Control Valves,
and Pumps**

Bifold® Group

**Pneumatic and
Instrumentation Valves**

Hydraulic Valves

Subsea Valves

**Hydraulic Pumps,
Intensifiers and Valves**

Bifold®

Bifold FluidPower®

Bifold® Subsea

Bifold®  Marshalsea

Accuracy of Information

We take care to ensure that product information in this catalogue is reasonably accurate and up-to-date. However, our products are continually developed and updated so to ensure accurate and up-to-date information please refer to the product catalogue issue list on our web site or contact a member of our sales team.

Quality Assurance

All Bifold products are manufactured to a most stringent QA programme. Every care is taken at all stages of manufacture to ensure that every product will give optimum performance and reliability. We are third party certified to BS EN ISO 9001:2008. Functional test certificates, letter of conformity and copies of original mill certificates, providing total traceability are available on request to BS EN 10204 3.1 where available. We reserve the right to make changes to the specifications and design etc., without prior notice.

When selecting a product, the applicable operating system design must be considered to ensure safe use. The products function, material compatibility, adequate ratings, correct installation, operation, and maintenance are the responsibilities of the system designer and user.

Bifold, Bifold Fluidpower, Bifold Subsea and Marshalsea Hydraulics Ltd are all members of the Bifold Group. Registered No. 1787729 in England. Registered Office: Greenside Way, Middleton, Manchester, M24 1SW.

UK Office
Bifold Fluidpower Ltd
Greenside Way,
Middleton, Manchester,
M24 1SW. UK.
Tel: +44 (0) 161 345 4777
Fax: +44 (0) 161 345 4780
Email: marketing@bifold.co.uk
Web: www.bifold.co.uk

Marshalsea Hydraulics Limited
Marshalsea House, Venture Way
Priorswood Industrial Estate
Taunton, Somerset, TA2 8DE. UK.
Tel: +44 (0) 1823 331081
Fax: +44 (0) 1823 323382
Email: info@marshalsea.co.uk
Web: www.bifold.co.uk

USA Office
Bifold Fluidpower Ltd
11490 Westheimer,
Suite 850,
Houston, TX, 77077.
Tel: +1 (713) 783 4253
Fax: +1 (713) 783 0067
Email: marketing@bifold.co.uk
Web: www.bifold.co.uk

Singapore Office
Bifold Fluidpower Ltd
Toa Payoh Industrial Park,
Lorong 8 #07-1475,
Singapore, 3109075.
Tel: +65 6735 1323
Fax: +65 6735 1367
Email: marketing@bifold.co.uk
Web: www.bifold.co.uk

**Innovative and Reliable
Valve Solutions**



www.bifold.co.uk